

PowerKit Engine 4M11 Series

General Specifications

Bore & Stroke	105x130 mm
Displacement	4.5 L
Cylinder Number	4
Compression Ratio	18:1
Fuel System	Mechanical Pump
Governor	Mechanic/Electronic
Aspiration	T/TA
Emission Standard	EU Stage II

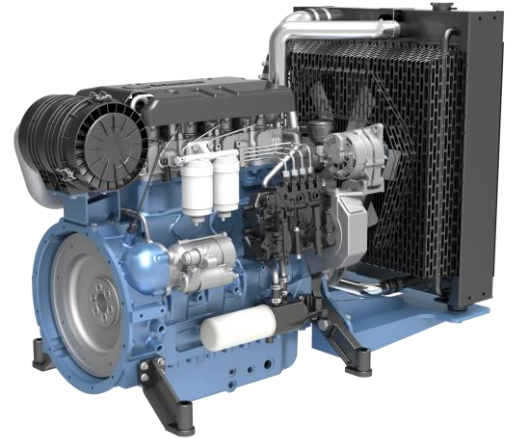

Engine Speed	Engine Output		Typical Generator Output (ESP)
	Prime(PRP)	Standby(ESP)	
RPM	kWm	kWm	kWe/kVA
1500	60	66	57/72
1500	74	81	70/88
1500	98	108	88/110

Engine Speed	Engine Output		Typical Generator Output(ESP)
	Prime(PRP)	Standby(ESP)	
RPM	kWm	kWm	kWe/kVA
1800	85	93	83/103
1800	108	118	100/124

Standard Equipment

Engine and block

- Cast iron gantry type structure block
- One-piece forged crankshaft
- Separate cast iron cylinder heads and wet liners
- Aluminum alloy pistons with gallery oil cooling

Cooling system

- Radiator and hoses supplied separately
- Thermostatically-controlled system with belt driven coolant pump and pusher fan

Lubrication system

- Flat bottom large capacity oil pan (10 L)
- Spin-on full-flow lub oil filter
- Special design connector for oil heater and drawing off oil pump

Fuel system

- P type fuel injection pump and injector for higher inject pressure
- Duplex fine filter and large capacity pre-filter for better efficiency

Air intake and exhaust system

- Top mounted turbocharger optimized for gen-set application
- Special rear mounted air filter with restriction indicator
- High performance silencer as standard
- Stainless steel exhaust manifold shield for heat isolating

Electrical system

- 24V electric starter motor and battery charging alternator
- Standard sensor connector

Flywheel and housing

- SAE3 flywheel housing and 11.5flywheel

	Continuous Power(COP)	Prime Power(PRP)	Standby Power(ESP)
Mean engine load factor	100%	≤70% per 250 h	≤80% per 24 h
Annual working time	Unlimited	Unlimited	≤200 h
Time at full load	Unlimited(Max. load≤85% PRP)	≤500 h per year	≤25 h per year
Overload capacity	NO	1 h per 12 h(10% overload) ≤25h per year	No

PowerKit Engine 4M11 Series

Dimensions and Weight

	T	TA
Length	1415 mm	1415 mm
Width	797 mm	797 mm
Height	1041 mm	1091 mm
Weight	650kg	700kg

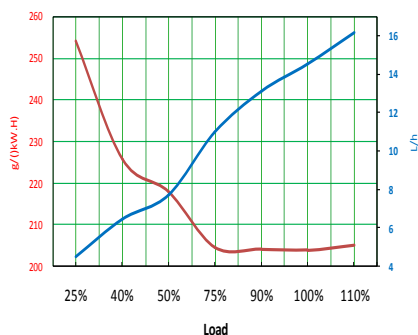
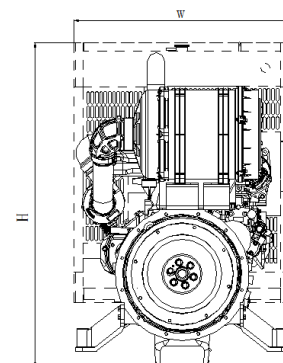
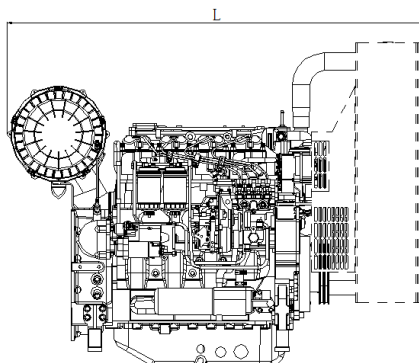

4M11G70/5e2-60kW/1500rpm

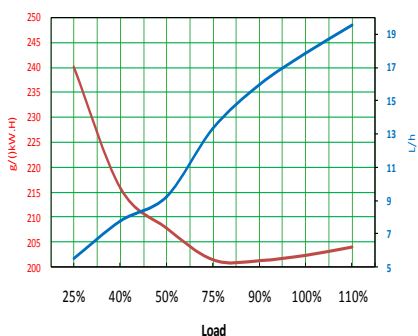

4M11G90/5e2-74kW/1500rpm

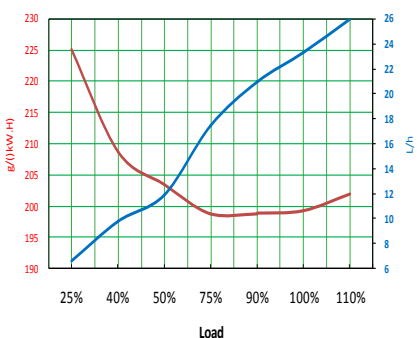

4M11G110/5e2-98kW/1500rpm

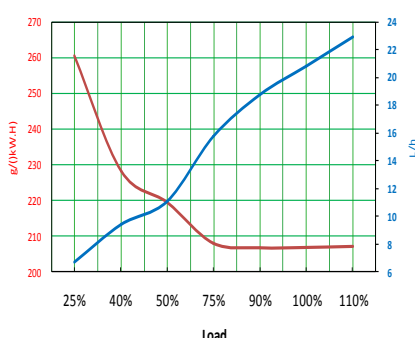

4M11G75/6e2-85kW/1800rpm

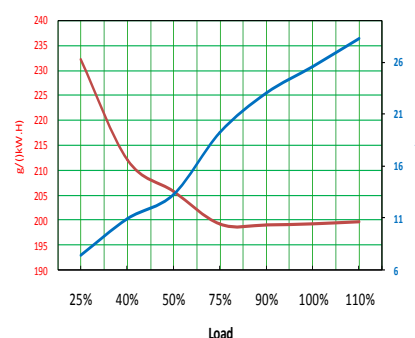

4M11G90/6e2-108kW/1800rpm

Powerdefinition

Standard ISO 3046/1 -1995(F)

Reference conditions

Ambient temperature	25°C
Barometric pressure	100kPa
Relative humidity	30%

Fuel

Relativedensity	0.840kg/L
Lower calorific power	42 700 kJ/kg
Consumption tolerances	± 5 %

Lube oil

Recommend grade	CF 15W/40
-----------------	-----------

Manufacturer: SOCIETE INTERNATIONALE DES MOTEURS BAUDOUIN
 Address: Technoparc du Bregadan
 13260 Cassis, FRANCE
<http://www.baudouin.com>